

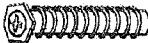







ASSEMBLY HARDWARE

- A  Long Bolts 8 PCS
- B  Short Bolts 2 PCS
- C  Lock Washers 8 PCS
- D  Metal Washers 8 PCS

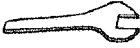
TOOLS REQUIRED

- E  Open Wrench 1 PC
-  Screwdriver (not included)

COMPONENTS

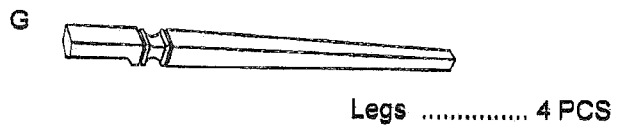

- * Please make sure you have all the hardware & components before assembling this item.
- * This item should be assembled on a soft surface to prevent making any scratches on its finish during the assembly.
- * This item may require periodic tightening.
- * Two (2) people are recommended to assemble this item.

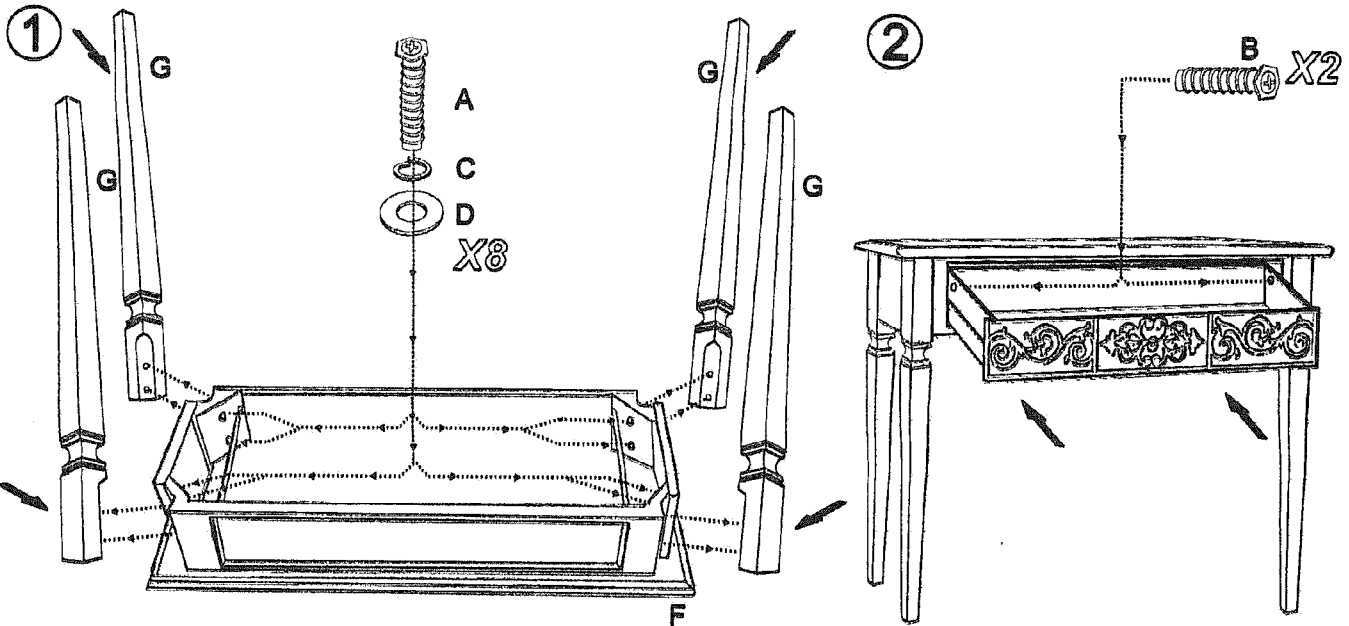

- 1a) Pull out the drawer from the Table Top (F). With the assistance of another adult, carefully place the Table Top upside down on a soft surface.
- 1b) Align the holes in the Legs (G) with the corresponding holes in the Table Top. Secure each Leg with 2 Bolts (A), 2 Lock Washers (C) and 2 Metal Washers (D) using Open Wrench (E) and screwdriver.
- 2a) Carefully turn the Console Table right-side up. Slide the drawer halfway into the Table. Reach inside the drawer and screw 2 Short Bolts (B) to it as shown. Secure, but do not over tighten the Bolts with Open Wrench (E) and screwdriver.
- 2b) Close the drawer.

CARE AND MAINTENANCE: Clean surfaces with a dry or damp soft cloth. Do not use abrasive cleaners.