

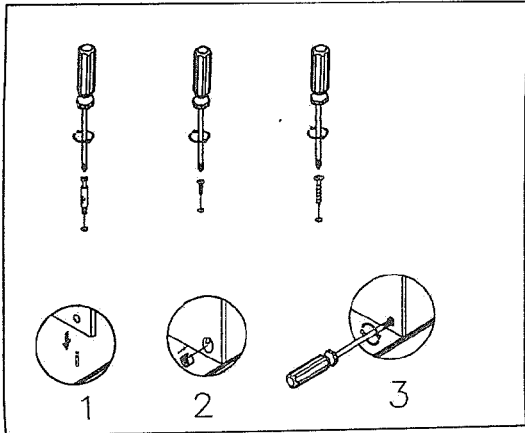

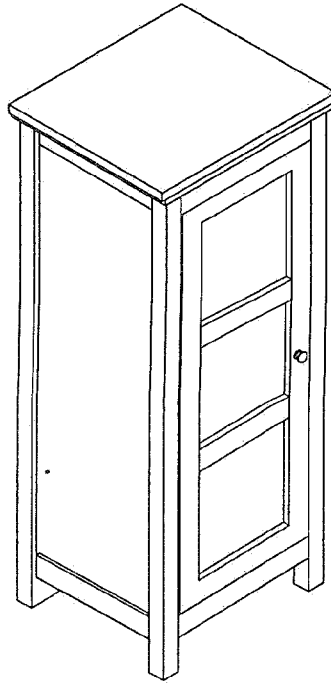

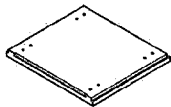





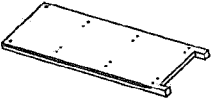
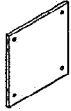
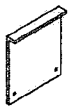

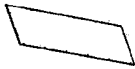

ASSEMBLY INSTRUCTIONS ALSTON STORAGE CABINET

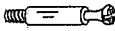

PART LIST

(A) Top Panel 1 pc 	(B) Left Side Panel 1 pc 	(C) Right Side Panel 1 pc 	(D) Shelf 2 pcs 	(E) Bottom Shelf 1 pc 
(F) Cross Brace 1 pc 	(G) Back Panel 1 pc 	(H) Door 1 pc 		

HARDWARE LIST

(1) Wood Dowels 20PCS 	(2) Cam Lock Screw 16PCS 	(3) Wood Screw ϕ 3X14 22PCS 	(4) Cam Lock 16PCS 	(5) Magnet Catch 1PC 
(6) Hinge 2PCS 	(7) Knob 1PC 	(8) ϕ 4X16 Philip Screw 1PC 	(9) Catch Plate 1PC 	(10) ϕ 3X12 Wood Screw 7PCS 

STEP 1. Attach Cam Lock Screws (2) Into Inserts In Top Panel (A), Side Panels (B) & (C) And Tighten.

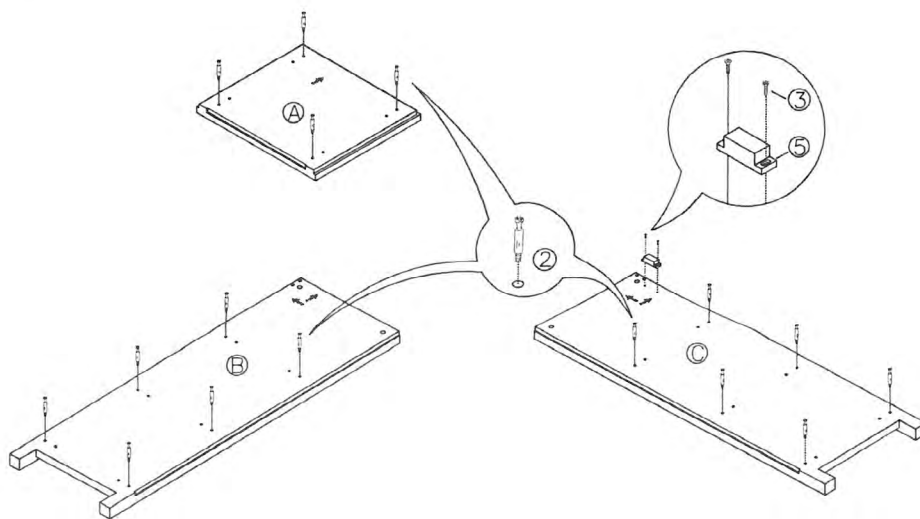

Step 2. Attach Magnet Catch (5) To Right Side Panel (C) With $\phi 3 \times 14$ Wood Screws (3) And Tighten.

Step 3. Attach Top Panel (A), Side Panels (B),(C), Shelves (D),(E) & Cross Brace (F) With Wood Dowels (1) & Cam Locks Screws (2) By Inserting Cam Locks (4) and Tighten Clockwise.

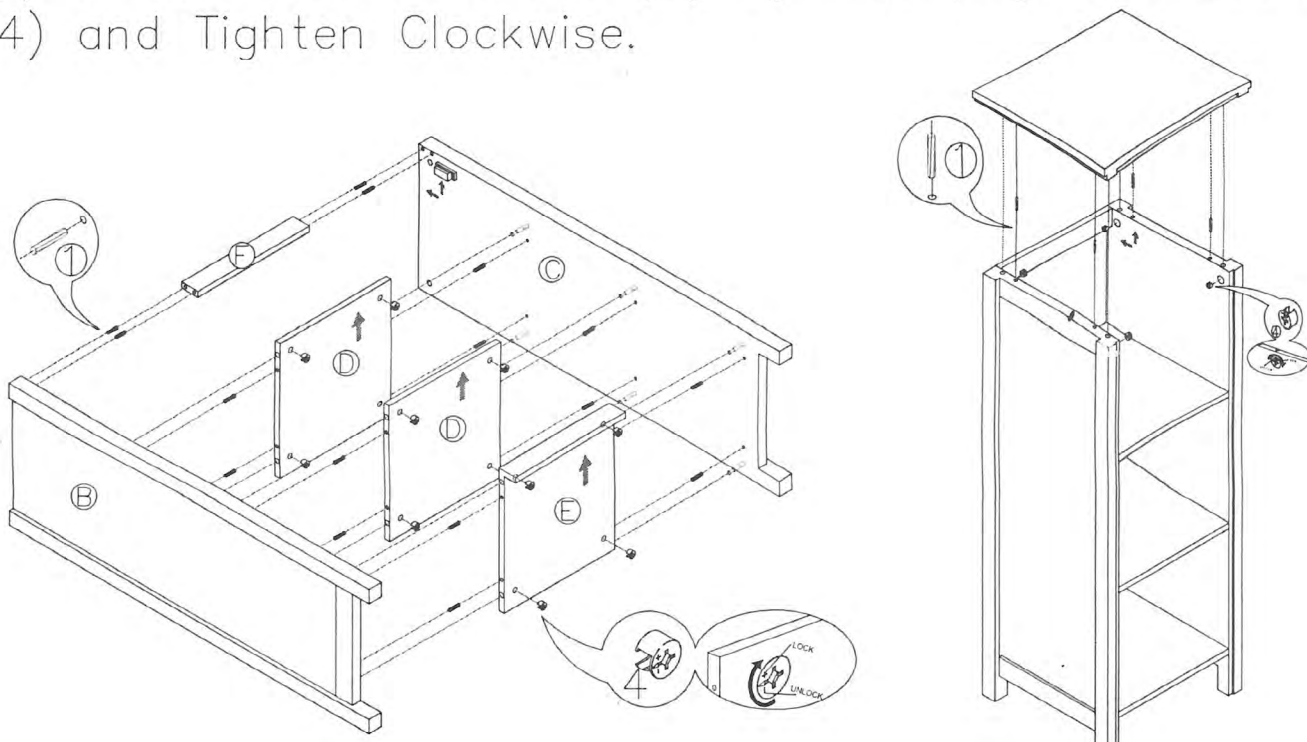

Step 4. Attach Hinges (6) & Catch Plate (9) with $\phi 3 \times 12$ Wood Screws (10) And Tighten.

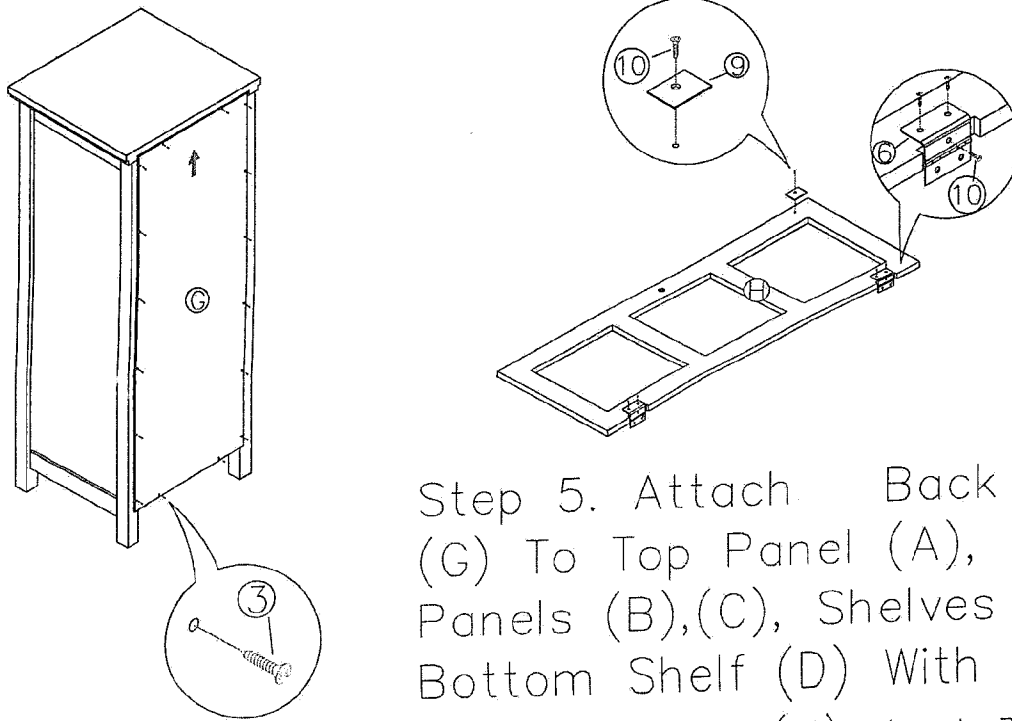

Step 5. Attach Back Panel (G) To Top Panel (A), Side Panels (B),(C), Shelves (D) & Bottom Shelf (D) With $\phi 3 \times 12$ Wood Screws (3) And Tighten.

Step 6. Attach Knob (8) To Door (H) With Philip Screw (9) And Tighten

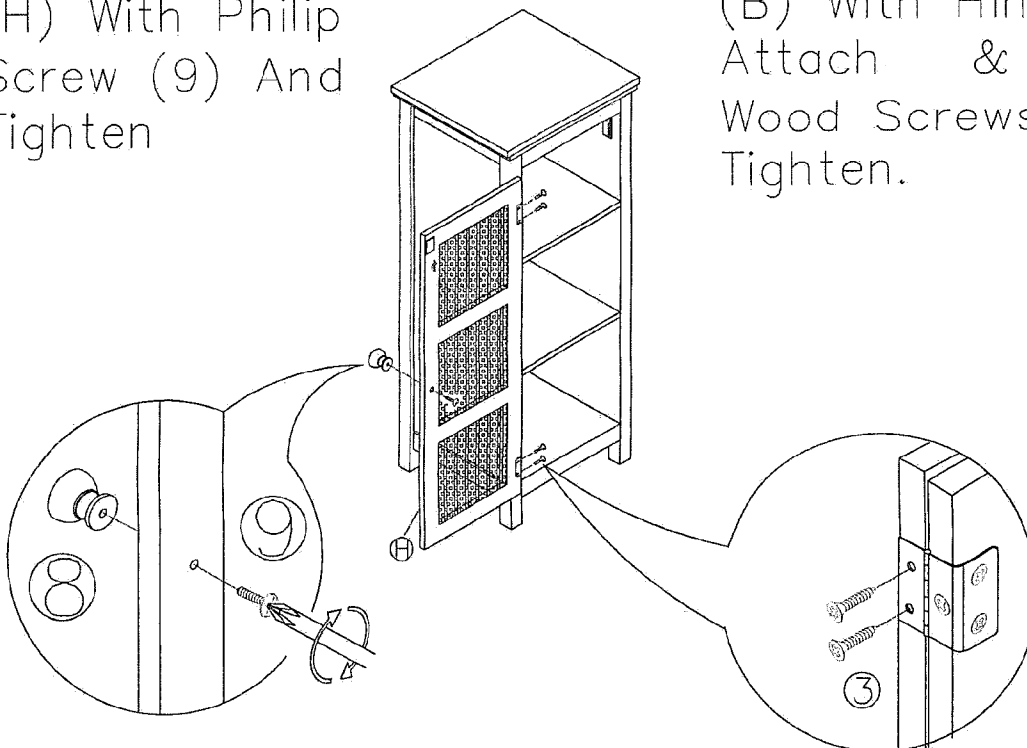

Step 7. Attach Door (G) To Left Side Panel (B) With Hinges (6) Attach & $\phi 3 \times 14$ Wood Screws (3) And Tighten.