

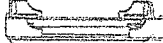





## ASSEMBLY INSTRUCTIONS

ITEM NO.: M10703

### Parts Required

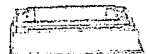
A		12pcs	E		1pc
B		12pcs	F		4pcs
C		8 pcs	G		1pc
D		1pc	H		4 pc

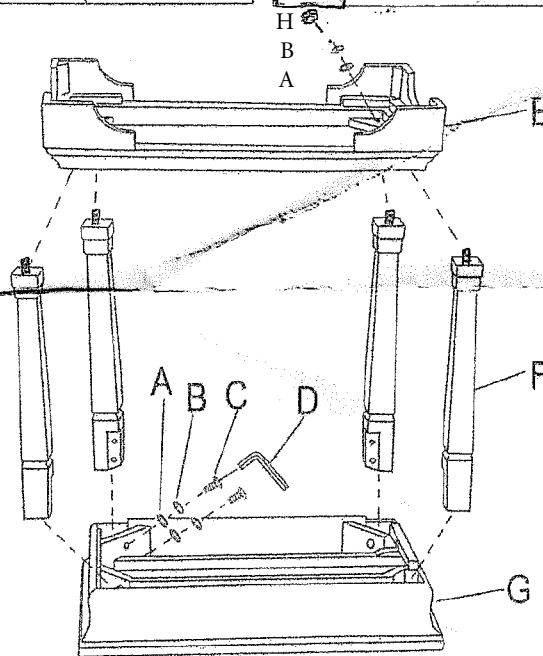

1. Take off all parts from carton. Take care of the parts, do not throw away by mistake.
2. Place table top (G) on a clean, flat surface. Attach legs (F) to table top (G) with flat washer (A) fist, then spring washer (B), and allen head bolt (C) by allen key (D). Do not tighten.
3. Attach bottom shelf (E) to legs (F) with flat washer (A) fist, then spring washer (B), and hex nut (H). Do not tighten.
4. Turn over the table, adjust stability and tighten all bolts. Your tray table is ready for use.