

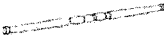

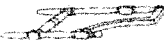





Assembly Instructions

ITEM NO: M20182

Parts required

A		1pc	D		2pcs
B1		1pc	E		12pcs
B2		1pc	F		12pcs
C		1pc	G		12pcs

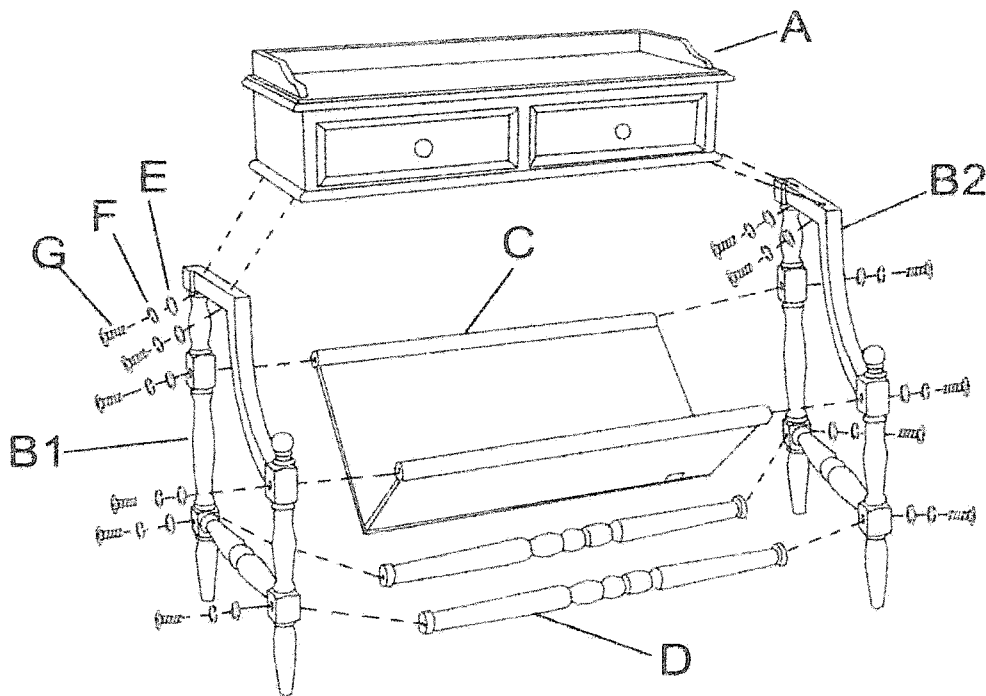

1. Take off all parts from carton. Take care of the parts, do not throw away by mistake.
2. Place the middle shelf (C) on the floor, vertical, Attach left frame (B1) and cross bars (D) to the middle shelf (C) with flat washer (E) first, then spring washer (F), then allen head bolts (G). Do not tighten.
3. Turn over and attach right frame (B2) to middle shelf (C) and cross bar (D). Do not tighten.
4. Attach table top (A) to left and right frame (B1, B2) with flat washer (E) first, then spring washer (F), then allen head bolts (G). Do not tighten.
5. Adjust stability and tighten all bolts. Your magazine table is ready for use.