









## ASSEMBLY INSTRUCTIONS

### Parts required

A		8PCS
B		8PCS
C		8PCS
D		4PCS

E		1PC
F		4PCS
G		1PC

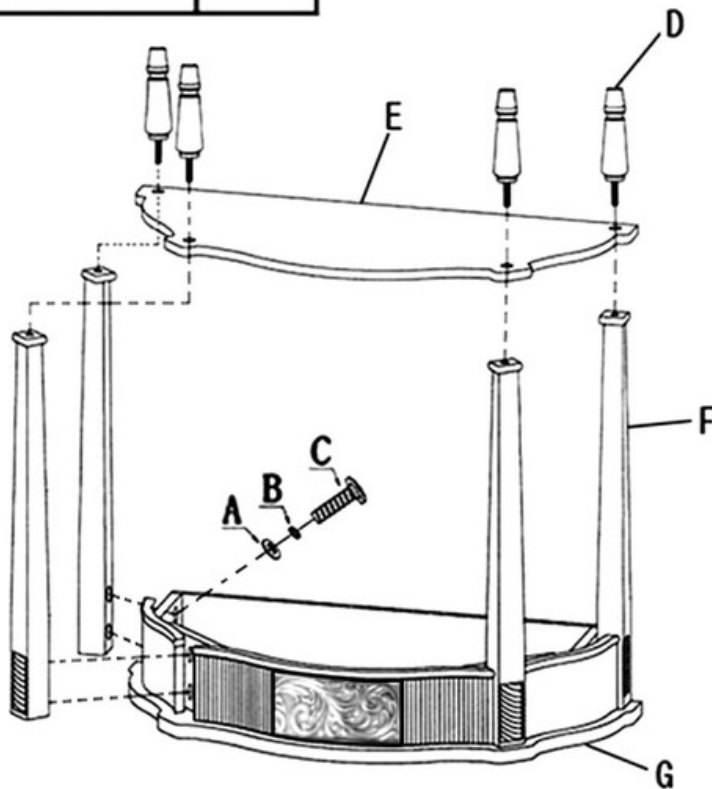

1. Take out all of the parts from the carton. Be sure to set the hardware package aside.
2. Place the wooden table top (G) on a soft, clean surface. Attach the wooden legs (F) to table top (G) with flat washers (A) first, then spring washers (B), and screws (C). Do not tighten.
3. Place the bottom shelf (E) on legs (F). Then screw bottom legs (D) into the bottom shelf (E). Adjust stability and tighten screws. Your table is ready for use.