

Carved Wall Mount Jewelry Mirror Parts List

Please review all parts and hardware before disposing of any packaging. Call Customer Service if missing hardware. Do not return to store/retailer. Screws shown in actual size. Using a screw that is too long will cause damage.

Before beginning assembly, separate each type of screw. Carefully study the screw diagrams below (SHOWN ACTUAL SIZE). You may receive extra hardware with your unit.

A

Quantity
of 1

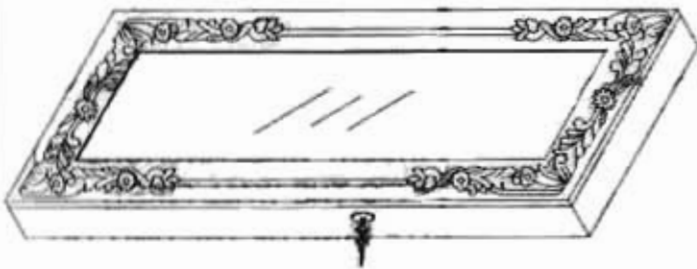

ARMOIRE

(1)

Quantity
of 3

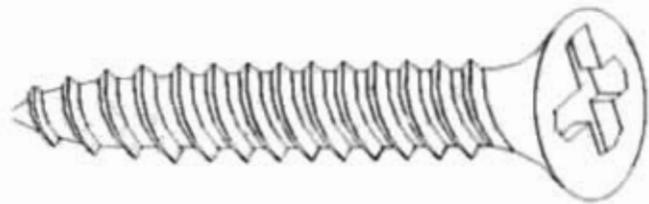

WOOD SCREWS

(2)

Quantity
of 3

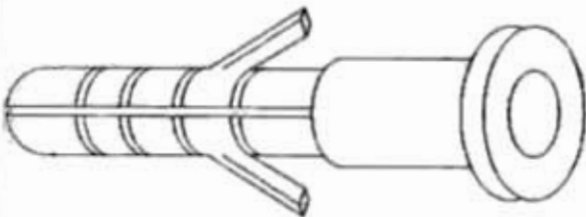

WALL ANCHORS

(3)

Quantity
of 2



KEYS

Care and Cleaning Instructions:
Before using, wipe with a clean, dry cloth. Periodically apply furniture wax to renew the finish. Avoid rubbing or scratching the surface with rough or abrasive objects.

For replacement parts or questions, please Call Customer Service at 1-800-633-5096 Do not return product to store, please call Manufacturer for assistance, questions or Parts.

Assembly Tool Required
No.2 Phillips Screwdriver

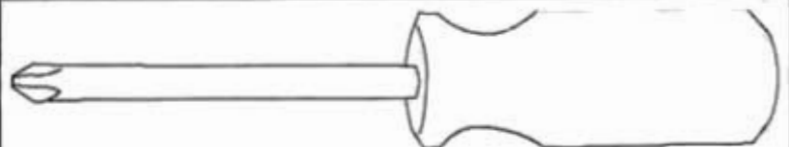

Assembly Instructions



WALL

OPEN THE CARTON, CLEAN THE UNIT (A) WELL AND OPEN THE DOOR PANEL. CHECK IF ALL THE PARTS INSIDE ARE PRESENT.).

Figure 1

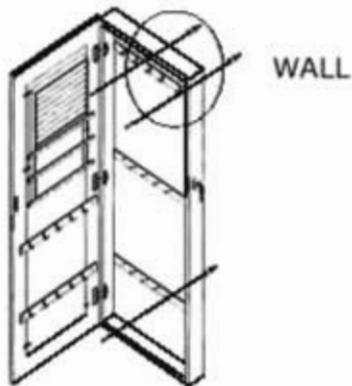

WALL

INSERT WALL ANCHORS (2) INTO THE WALL FIRST; LOCKING UP THE UNIT (A) INTO THE WALL WITH WOOD SCREWS (1); AND LAST CHECK IF THE UNIT (A) IS ATTACHED ON THE WALL FIRMLY.

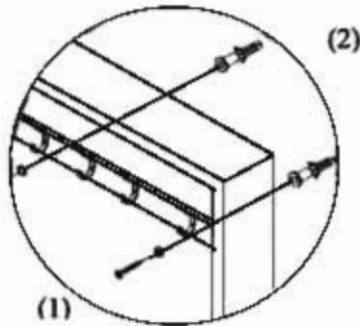
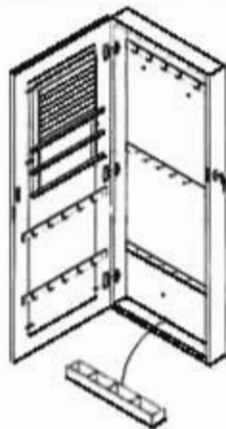

Figure 2



PUT THE APARTMENT INTO THE UNIT.

Figure 3