

Bed Steps Assembly Instructions

Step①

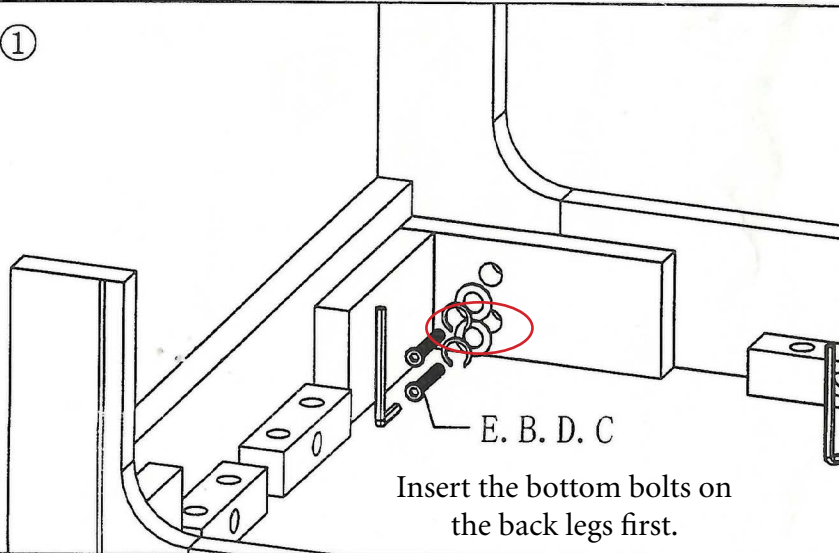

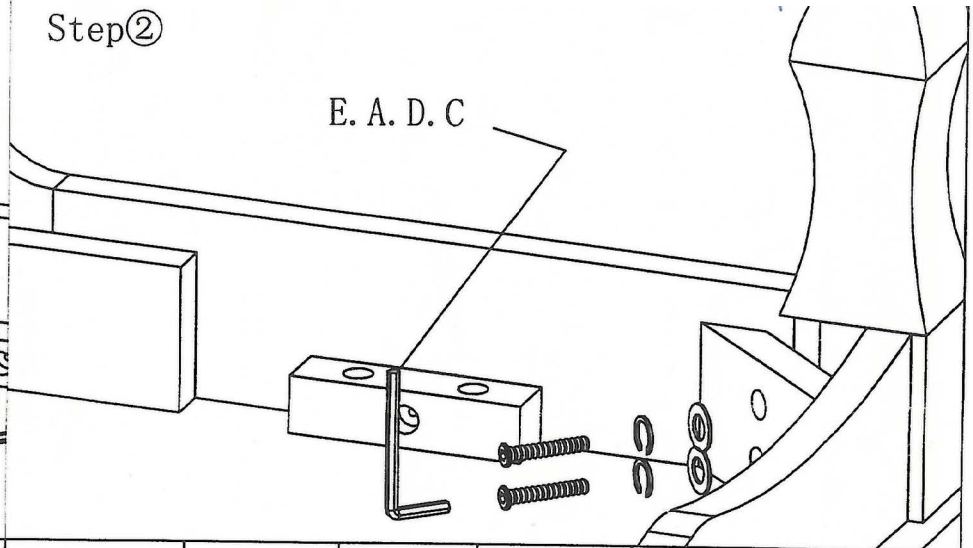



Step②

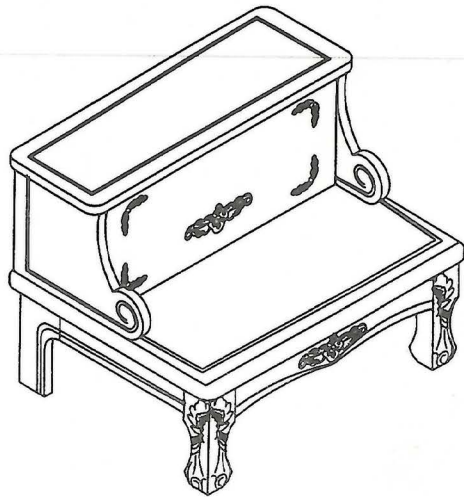

Final

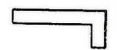

NO.	A	B	C	D	E
hardware					
QTY	4pcs	4pcs	8pcs	8pcs	1pcs
Size	1/4*2"	1/4*1 1/4"	1/4*16	1/4*13	4mm