

INSTALLATION INSTRUCTIONS FOR ROD SET

NOTE: Finial shown is for illustration purpose only. It may not represent the style of finial purchased.

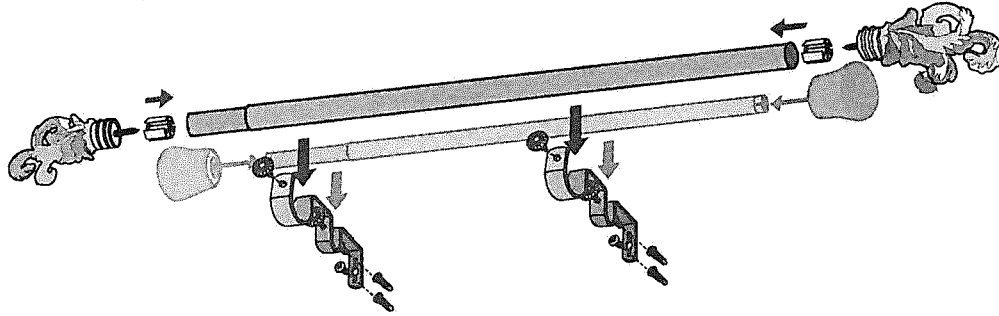

- 1** Place brackets against wall at desired locations. Mark screw holes with pencil. Be sure marks are level across opening.

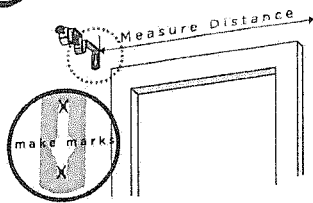

- 2** If screws are going directly into wood trim or wall studs, drill a 1/8" pilot hole at pencil marks. If screwing into drywall, follow drywall anchor instruction in the bottom of the page.

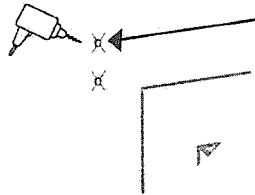

- 3** Assemble rod and sheer drapery treatment onto rod.

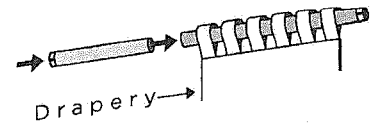

- 4** **MOUNTING FINIALS**
There are two diameters of white inserts included. For a three piece rod, there is only one diameter of white insert. Turn the end of the finial screw (clockwise) into flattened end of the white insert until base of the finial is snug to insert face.

Push each insert into the (corresponding size) end of the pole with the fins of the insert going into the pole.

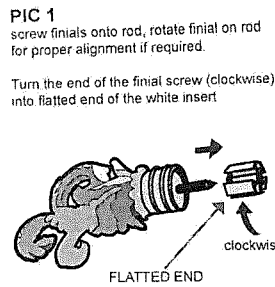

- PIC 2**
insert until base of the finial is snug to insert face

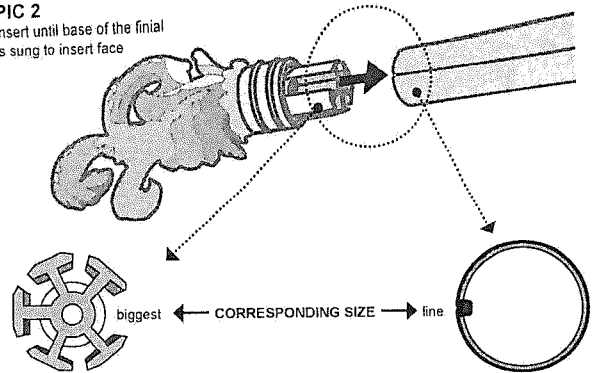

- 5** Extend rod to desired width. Lift rod with drapery and drop into brackets. Adjust draperies to desired position.

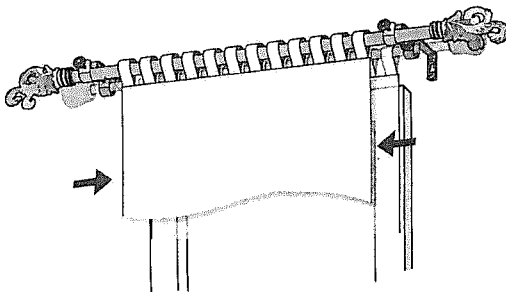

- 6** Lock rods into position by tightening leveling screw by hand until finger tight. This will prevent the rod from moving.

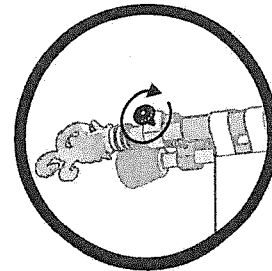

DRYWALL ANCHOR INSTALLATION



If screws are going directly into wood trim or wall studs - drill 1/8" (3mm) holes and install screws through bracket. If screws are going into hollow wall - drill 3/16" (5mm) holes and push or lightly hammer plastic anchors into holes. Then install screws through brackets. Do not tighten screws too much - just snug is best.