

INSTALLATION INSTRUCTIONS FOR 5/8" DOUBLE ROD SET

ADAPTER PACK (A) – Finials with a post

NOTE: These instructions are for finials with a post that use ADAPTER PACK (A).
If your finial is a hollow slide-on type, please see the reverse side of these instructions.

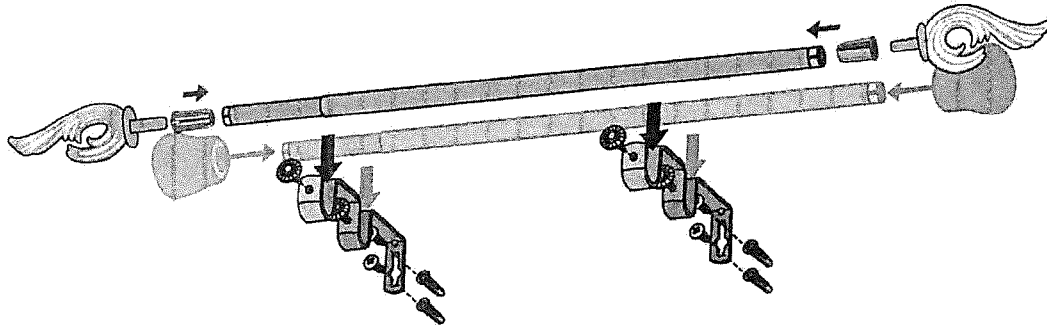

1 Place brackets against wall at desired locations. Mark screw holes with pencil. Be sure marks are level across opening.

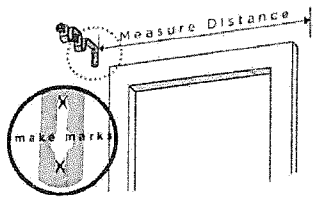

2 If screws are going directly into wood trim or wall studs, drill a 1/8" pilot hole at pencil marks. If screwing into drywall, follow drywall anchor instruction at the bottom of the page.

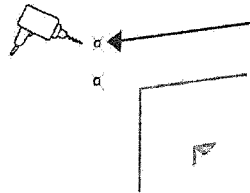

3 ASSEMBLE ROD
Assemble the rod by inserting and sliding the smaller diameter rod into the larger diameter rod. For a three piece rod, place the single rod size in the center position.

4 ATTACHING DRAPERY
Slide the drapery onto the pole.

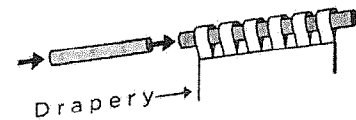

5 ATTACHING FINIALS
There are two sizes of adapters included. For a three piece rod, there is only one size of adapters.

a. Push corresponding insert into each end of rod with the fin side going into the pole and the flatted end facing out.

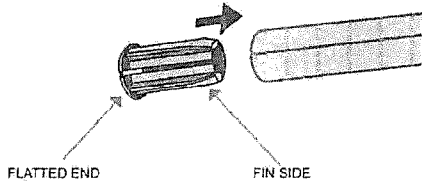

b. Attach finials by pushing the end of the finial post into the end of the plastic insert until completely snug. Rotate finial on rod for proper alignment if required.

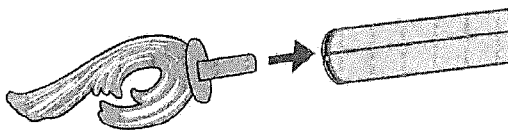

6 Extend rod to desired width. Lift rod with drapery and drop into brackets. Adjust draperies to desired position.

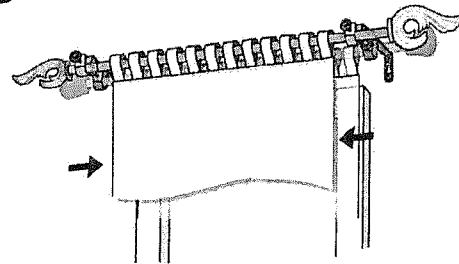

7 Lock rods into position by tightening leveling screw by hand until finger tight. This will prevent the rod from moving.

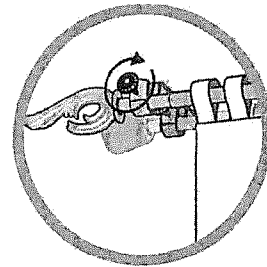

8 Extra adapters pack can be discarded.

DRYWALL ANCHOR INSTALLATION



If screws are going directly into wood trim or wall studs - drill 1/8" (3mm) holes and install screws through bracket.
If screws are going into hollow wall - drill 3/16" (5mm) holes and push or lightly hammer plastic anchors into holes. Then install screws through brackets. Do not tighten screws too much - just snug is best.

Please note: This diagram is a representative drawing and not intended to match the style of your new rod set.

AT

TOC20191209