







Examine all packaging material for small parts that may have come loose during shipment. Periodic checks are recommended to insure that all components are in proper position, tight and free from damage. Keep this assembly instruction for future reference. Adult assembly is required. The product of Hillsdale Furniture, LLC is designed for residential use only. Customer Service Phone Number: 502-562-0000

HARDWARE LIST

- A (12) 1/4" x 5/8" Allen Bolts
- B (4) 1/4" x 1/2" Allen Bolts
- C (16) 1/4" Spring Washers
- D (12) 1/4" 16mm Flat Washers
- E (4) 1/4" 13mm Flat Washers
- F (1) Hex Wrench

PARTS LIST

- G (1) Stool Top
- H (2) Left Legs
- I (2) Right Legs
- J (1) Cross Brace

PART	QTY	HARDWARE	PART	QTY	HARDWARE
A	12		B	4	
C	16		D	12	
E	4		F	1	

STEP 1

Begin assembly by attaching each Leg (H & I) to the bottom of the Stool Top (G) by aligning holes and securing with 2 Allen Bolts (A), 2 Spring Washers (C) & 2 Flat Washers (D) per each leg. See **Figure 1**. Do not fully tighten bolts for this step.

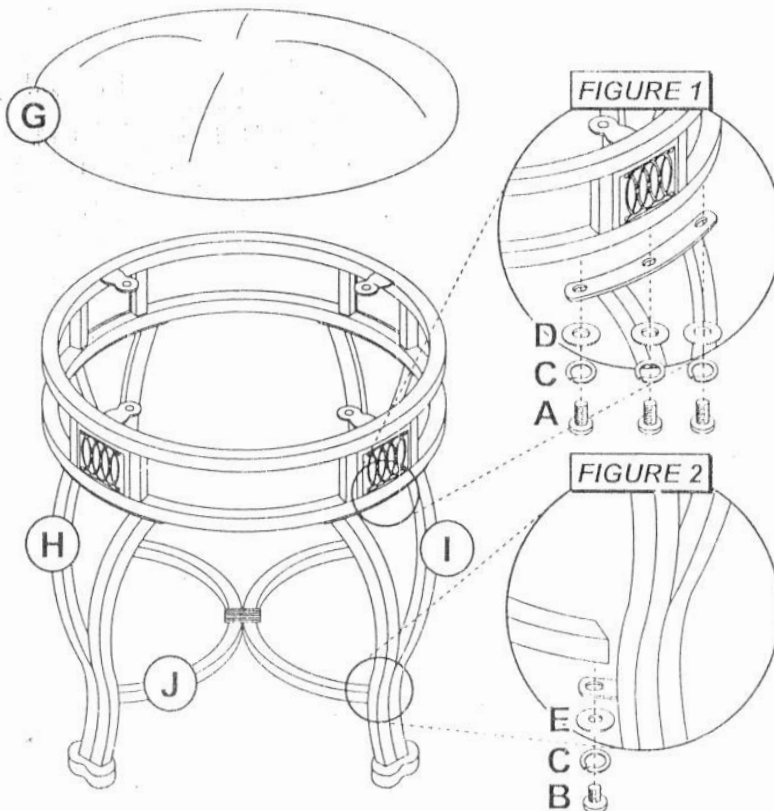

STEP 2

Once each Leg (H & I) is in place, secure the Support Brace (J) to the inside of each leg by resting in place and securing with 1 Allen Bolt (B), 1 Spring Washer (C) & 1 Flat Washer (E) per each leg. See **Figure 2**. Tighten all bolts from Steps 1 and 2 using the Allen Wrench (F) that has been provided. The assembly is now complete.

CARE & MAINTENANCE: The touch of a soft cloth is all the maintenance the finish will ever need. Please do not use harsh or abrasive cleaners for polishing, as they may cause damage to the finish. Periodic checks are recommended to make sure that all bolts, screws and nuts are securely tightened.

TOC20120504