

TC01 ASSEMBLY INSTRUCTION

Step①

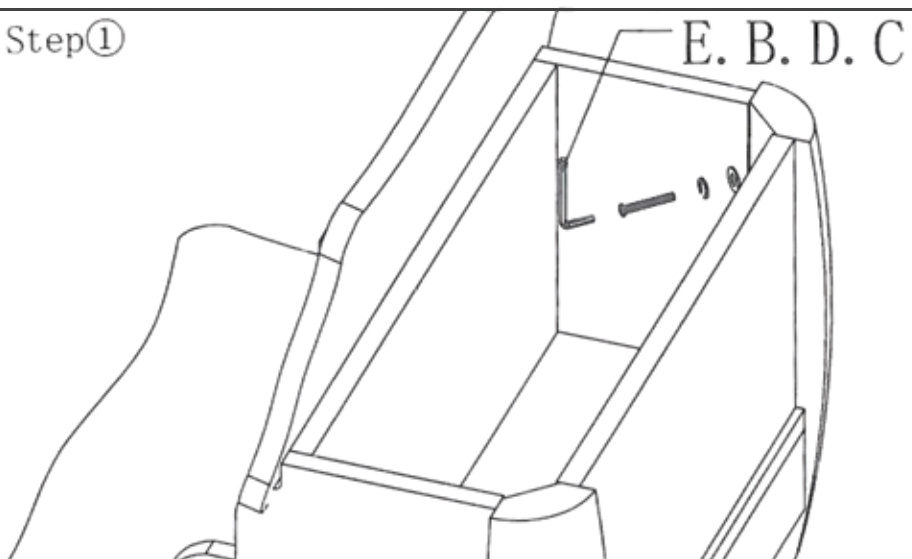

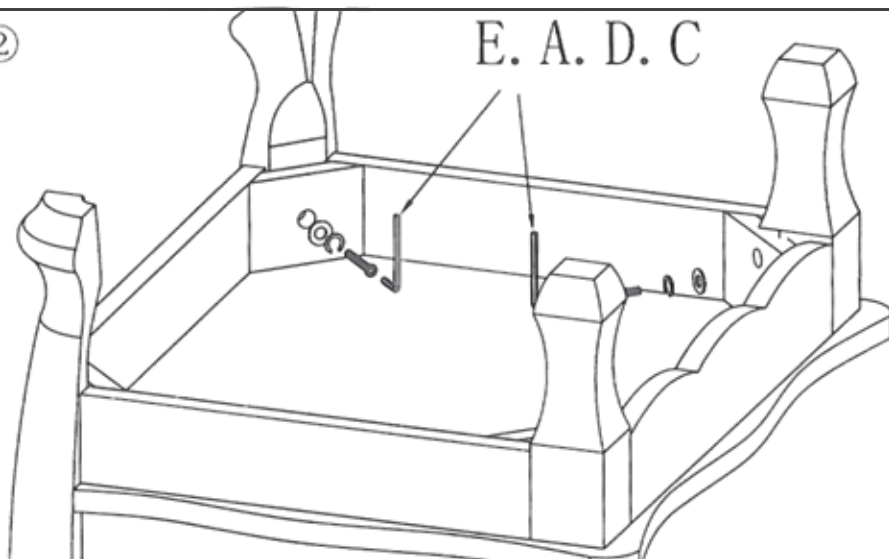



Step②

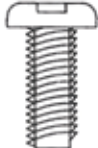

Final

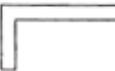

| No. | A | B | C | D | E |
|----------|---|---|---|---|---|
| Hardware |  |  |  |  |  |
| QTY | 6PCS | 2PCS | 8PCS | 8PCS | 1PCS |
| Size | 1/4*2" | 1/4*1 1/4" | 1/4*16 | 1/4*13 | 4mm |