







Assembly Instructions

Parts required

A		1pc	D		4pcs
B		2pcs	E		8pcs
C		1pc	F		10pcs

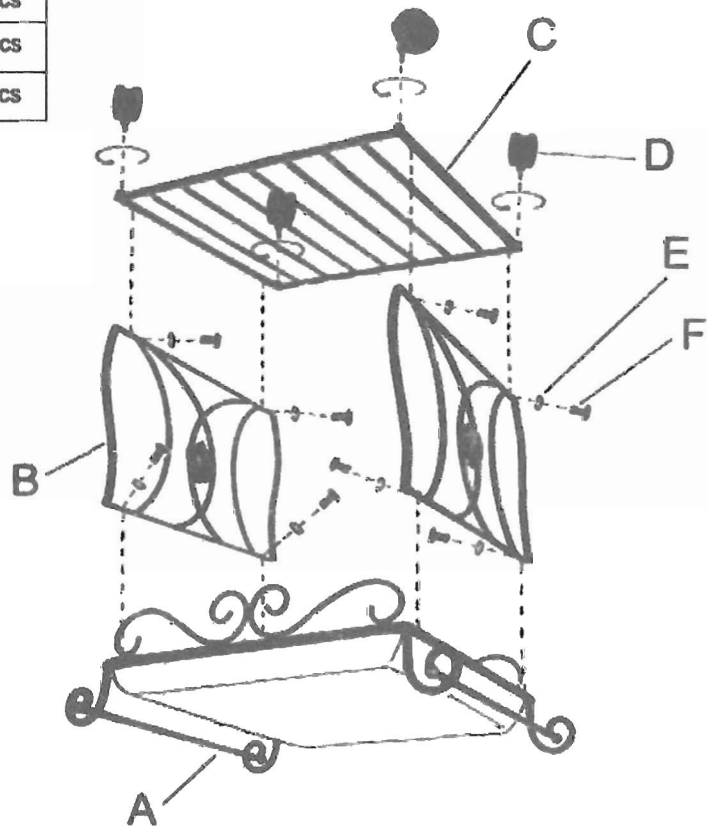
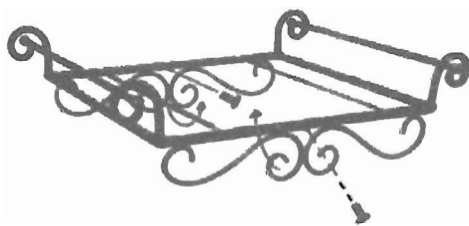

1. Take off all parts from carton carefully.
2. Open top cushion (A) 's folded aprons, make them straight And fasten with screw (F)
3. Place cushion (A) on a soft, clear surface, attached side panels (B) to top cushion (A) by spring washer (E) first, then screws (F) Do not tighten.
4. Attached bottom frame (C) to side panels (B) by spring washer (E) first, then screws (F), Do not tighten.
5. Screws all 4 wheels (D) to bottom frame (C).
6. Turn over the bench, adjust stability and tighten all screws.
7. Your bench is ready for use.