

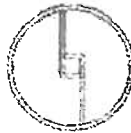



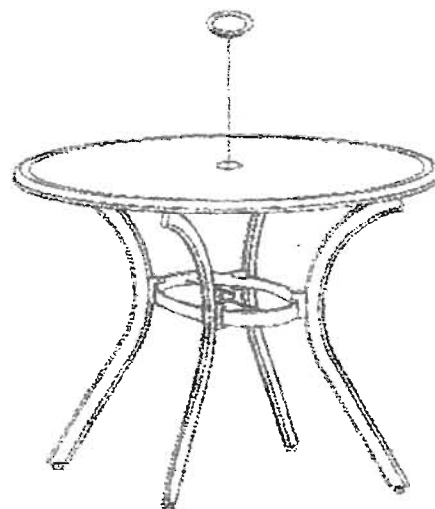

NO.	Part	Qty.
1		1
2		1
3		4
4	 1/4 x 15	8
5	 1/4 x 20	8
6	 Ø16 x Ø6.5 x 1	16
7		1
8	 1/4	1



VT-01