



**ITEM #:** MB5454PT  
**Description:** MONTBLANC COUNTER TABLE  
**Product size:** 54" x 54" x 36"H

**Your furniture purchase is an investment. Furniture can last life times, with a minimum amount of effort. Here are a few tips to properly care for your furniture, ensuring that it looks great year after year.**

**Wood Furniture Maintenance:**

- Always dust, wipe, and clean with the grain of the wood.
- Dust with a soft cloth. Dust will scratch the furniture surface if not removed properly.
- Use the same type of polish consistently as interchanging oil-based and wax-based polishes will cause a build-up and result in a foggy or cloudy appearance.
- If a polished surface become foggy, rub it with a cloth dipped in a solution of one tablespoon vinegar to one quart of water. Rub softly with the grain until the surface is completely dry.
- Soap and water are not advisable for wood surface, causing damage.
- Remember to change dusting cloths frequently as dirty cloths may scratch your furniture's surface.

**The Enemies of Wood:**

- Moisture is wood's worst enemy. Liquid spills should be gently wiped up immediately. Coasters should be used under all beverages.
- Do not allow rubber or vinyl materials to lie on the furniture. Chemicals in rubber may leave a stain. Put a strip of felt or leather under accessories that have rubber or vinyl.
- Heat creates a chemical change in the furniture's finish, which results in a white spot. Use protective pads under hot dishes, appliances, etc.
- Sunlight's ultraviolet rays can damage the finish of furniture. Do not place furniture directly against a heater or radiator and do not place in the path of hot streams of air from central heating. This will cause extreme localized drying of the wood.

**High Gloss Resin Table Maintenance:**

- Resin tabletops have approximately 1/8" of a resin coat on the top face of the table, which will resist ice, water, wine, liquor, food, cleaning fluids, and warm or hot liquids; however, cups, glasses, etc, containing hot liquids should not be left on the table without a coaster for protection.
- Resin tabletops will scratch just the same as any other glossy surface and basic precautions should be taken.
- For lasting shine, the resin table should be waxed with a car wax that does not contain silicon. Maintaining this wax build-up will result in a high gloss shine.
- When wiping down the table, a soft, clean rag should be used. Do not use a heavy paper.

**Granite Top Maintenance:**

- The surface of the granite on your table has been polished or sealed to create a generally non-porous surface. The stone has many natural characteristics including : veining, hairline cracks, and color variations- which make up the stone's beauty.
- To maintain the beauty of your granite:
- Protect surfaces from scratching, staining and etching by
    - \* Keeping them free of debris or sharp objects.
    - \*Wiping up spills immediately.
    - \*Avoiding contact with chemicals (particularly acid-based materials)
  - Clean with pH neutral products or those especially formulated for use on stone.
  - Renew the surface on polished granite (granite with a high gloss surface) by buffing with special stone polish, powder or cream.
- Do not use granite polish on granite with a matte finish, which has been honed rather than polished. (Penetrating sealer may be used on both polished and honed granite)







**Marble Top Maintenance:**

- Marble may be stone, but it is porous stone and can stain easily. Treating marble surface the same as wood surfaces is a great rule of thumb.
- It is recommended to seal the tops on a regular basis (every 6 to 12 months).
- A good quality stone sealer can be purchased from any tiles/stone store or any homecare store and should be applied according to the manufacture's recommendation.
- When sealed properly, marble tops can be used indoors and outdoors and can withstand any weather conditions except internal freezing. Snow or freezing rain will penetrate the table and cause cracks.

**Caring for the Fabric on Upholstered Furniture:**

- Frequent vacuuming of the entire upholstered area will prevent dust from settling in to the fibres.
- Professional cleaning is always recommended for all upholstered pieces.
- Always pre-test a small area of fabric in a inconspicuous area when cleaning before proceeding.
- Do not use cleaning products containing brightening agents.

**VERY IMPORTANT !!**

<p><b>NEVER</b> USE GLASS CLEANERS ON FINISHED SURFACE. AMMONIA WILL CHEMICALLY ATTACK THE FINISH.</p>	<p>DO NOT WRITE DIRECTLY ON SURFACE</p>  <p>PREVENT MARKING</p>	<p>DO NOT PLACE DIRECTLY IN SUNLIGHT</p>  <p>PREVENT FADING</p>	<p>DO NOT USE PLACEMATS WITH RUBBER BASES</p>  <p>PREVENT DISCOLORING</p>
<p><b>NEVER</b> ALLOW LIQUIDS OF ANY KIND TO LINGER ON SURFACE. ABSORPTION CAUSES THE WOOD TO WARP AND THE FINISH TO DE LAMINATE</p>	<p>DO NOT USE COMMERCIAL POLISHES AND WAXES</p>  <p>PREVENT YELLOWING</p>	<p>DO NOT PLACE HOT POTS, ETC ON SURFACE</p>  <p>PREVENT DAMAGE TO FINISH</p>	<p>DO NOT USE COMMERCIAL POLISHES AND WAXES</p>  <p>PREVENT SPLITTING</p>

TOC20120620

## ASSEMBLY INSTRUCTIONS

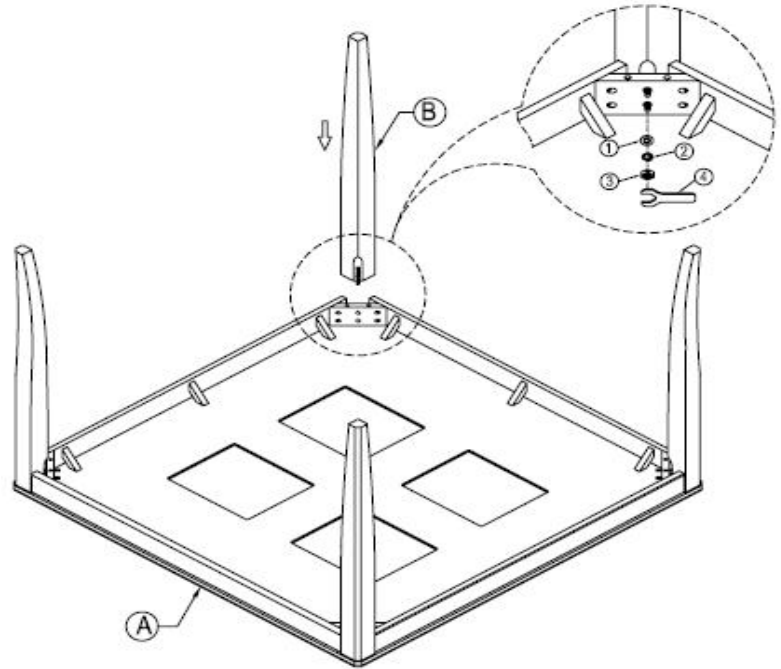

Place the Table Top (A) upside down on the floor with a piece of cloth or carpet underneath to prevent the finish from scratching. Attach the Table Leg (B) to the corner of Table Top (A) and secure with Flat Washer (1), Spring Washer (2) and Hex Nut (3). Tighten by Wrench (4). Repeat this step for the remaining three legs. Replace the assembled right up.

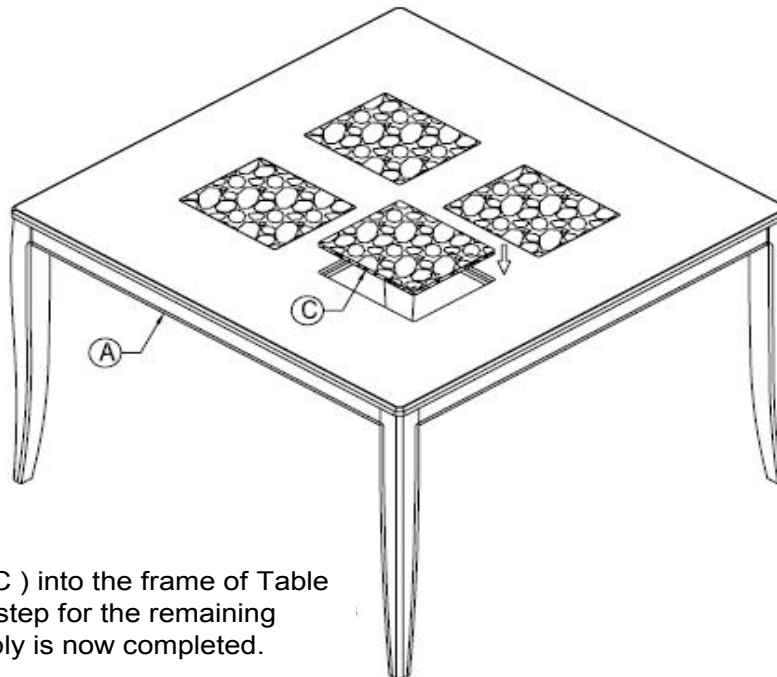

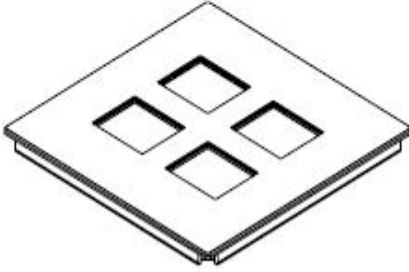
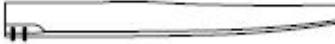
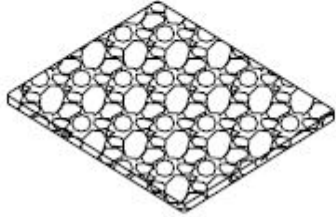

Insert the Top Glass (C) into the frame of Table Top (A). Repeat this step for the remaining three glasses. Assembly is now completed.

## PARTS LIST

(A) TABLE TOP (1 PC)	(B) TABLE LEG (4 PCS)	(C) TOP GLASS (4 PCS)
		

## HARDWARE PACK # : PMB5454PTH

No.	DESCRIPTION	DIMENSION	Q'TY
1	FLAT WASHER	 5/16"× ∅22×2mm	8 PCS
2	SPRING WASHER	 5/16"× ∅13mm	8 PCS
3	HEX NUT	 5/16"×13mm	8 PCS
4	WRENCH	 12 x 2 x 90mm	1 PC

**PARTS FOR MB5454PT  
COMPLETE HARDWARE # : PMB5454PTH**

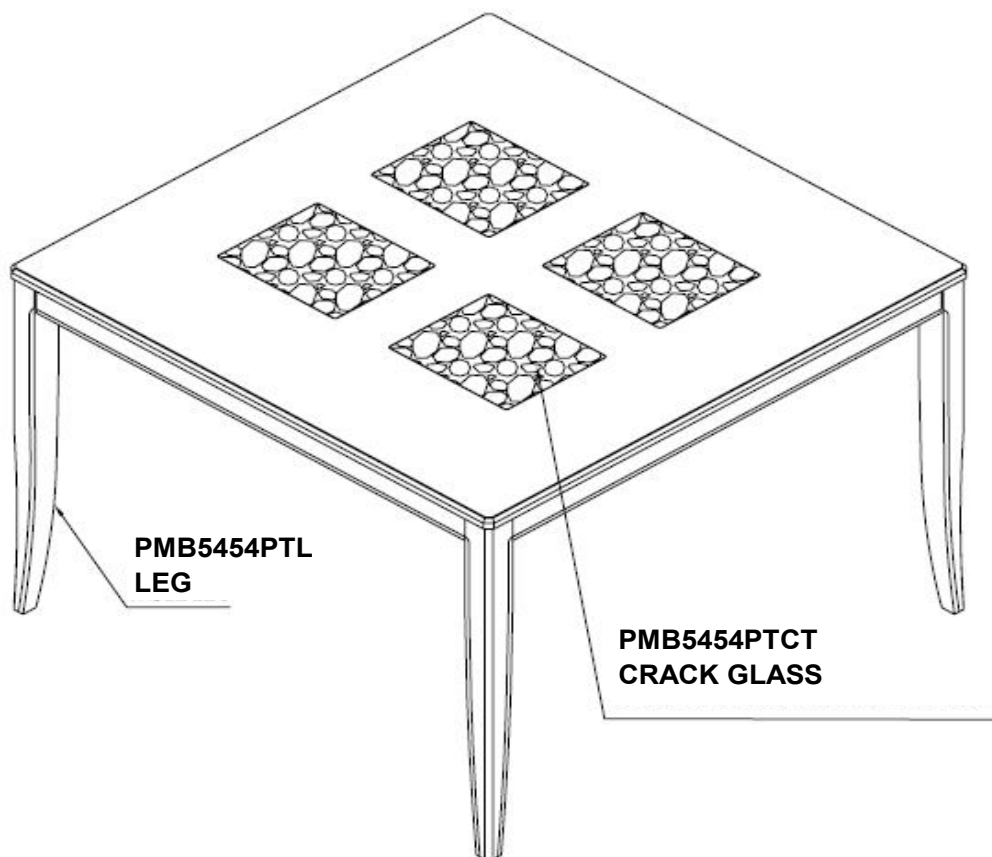

**PRODUCT DETAILS**

TOP	BIRCH VENEER ON MDF
APRON	RUBBER WOOD
LEG	RUBBER WOOD
PRODUCT SIZE	54" x 54" x 36"H
CARTON SIZE	57.08" x 57.08" x 7.08"
NET WEIGHT	107.8 LBS
GROSS WEIGHT	136.4 LBS
CU. FT.	13.36'

**MADE IN VIETNAM**